

PiHab™

User Manual

Release: October 2015

Closed Loop Grit Blasting





Any person intending to operate this equipment or any person intending to be in the vicinity during its operation must receive proper training.

Do not operate this equipment before reading and completely understanding all the warnings, cautions, operating procedures, and instructions contained in this manual. Do also read and understand the manual of the Pinovo® closed loop blasting and recycling unit PiSys™ 100 and other relevant tools used with this equipment.



Patent pending

1 INTRODUCTION

The PiHab™ is a flexible, transparent, abrasive blasting enclosure to be used with the Pinovo® closed loop grit blasting units PiSys™ 100 or PiSys™ 1000. The PiHab™ is easily adaptable to various complex pipe- or beam-based structures. The surface is blast cleaned by using Pinovo® Blasting Media. “White Metal” surface cleanliness according to SA 3 (ISO 8501-1) and SSPC-SP5 can be easily achieved in addition to an anchoring profile up to 120 µm.

Another advantage of Pinovo® grit blasting tools is the closed loop circulation system covering the entire treatment process. The result is the elimination of discharges related to the work, as well as excellent utilization of the blasting medium. Pinovo® Blasting Media circulates in the system and may be re-used up to 20 times reducing media consumption and waste generation up to 90 % compared to conventional dry abrasive blasting technologies. In addition, the operators are never in direct contact with the actual blasting and waste material, which is collected automatically in the integrated waste management system.

No significant clean-up or further work is required after the Pinovo® preparation process, the surface is ready for painting or other post-treatment. Reduced noise and dust free Pinovo® surface preparation process minimizes the impact on surrounding trades and equipment.

2 SAFETY INSTRUCTIONS







The products described in this manual are intended for knowledgeable, experienced users of abrasive blasting equipment. It is the responsibility of the user to ensure that proper training has been completed and to have the relevant certificates from the Pinovo training program (www.picademy.no).

It is the responsibility of the users to familiarize themselves with the appropriate laws, regulations and safe practices that apply to these products and materials that may be used with these products, and that a safe work environment is provided.

Any use outside the sphere of application specified by Pinovo is not approved. Such use, any failure to comply with the instructions given herein, or any modification of the product without the explicit written consent of Pinovo will invalidate the warranty, and Pinovo refuses to accept liability.

In addition to information on installation and operation, this instruction manual may contain **WARNINGS** and **CAUTIONS** pertaining to user safety. A **WARNING** indicates a potentially hazardous situation, which if not avoided, could result in death or serious injury. A **CAUTION** indicates a potentially hazardous situation, which, if not avoided, may result in minor or major injury. Do not attempt to operate this tool until you have read and understood all safety precautions and instructions listed in this manual. **INCORRECT OPEARATION OF THIS UNIT CAN CAUSE SERIOUS INJURY.**

2.1 Warnings

 WARNING	Closed loop grit blasting equipment may cause serious injury – protect hands, feet, eyes and hearing.
 WARNING	Show outmost care when connecting and operating the system. ALWAYS THINK SAFETY FIRST!
 WARNING	Wear PPE at all times when operating the PiHab™. The type of respiratory protection should be considered depending on material being removed, e.g. lead-based coatings.
 WARNING	Do not use closed loop grit blasting tools on surfaces of unknown thickness or temperatures above 70°C without proper risk assessment.
 WARNING	Before starting the PiHab™, ensure that all fixing screws, bolts and fittings are mounted correctly and securely tensioned. Also ensure that whip-checks and safety pins are used for all hose-connections and hook-ups.
 WARNING	Check all hoses for damage before starting the system.
 WARNING	Do not blast directly on the PiHab™ enclosure. Check integrity of blasting enclosure regularly during the blast cleaning work.

⚠ WARNING	Do not repair or replace any portion of Pinovo equipment using components that are not original Pinovo replacement parts or components that are not approved by Pinovo.
⚠ WARNING	Do not cut, obstruct, restrict or pinch pneumatic control lines. Doing so could prevent the proper activation and deactivation of the remote control system, resulting in the release of high speed media and compressed air.
⚠ WARNING	The use of this product for any purpose other than originally intended or altered from its original design is prohibited.
⚠ WARNING	You must NEVER place your hand or fingers underneath the ‘Blast Nozzle’ or point the ‘Blast Nozzle’ of the PiHab™ at yourself or anybody else while the system is pressurised.

2.2 Cautions

⚠ CAUTION	Never install, remove or perform any maintenance on the PiHab™ when the system is pressurized.
⚠ CAUTION	Always use the dead man’s switch when operating the system. The dead man’s switch must never be set deliberately in an interlocked or blocked position, which could hamper the safety release of the switch.
⚠ CAUTION	Only use Pinovo® Blasting Grit in the appropriate size, preferably sizes F12 to F46
⚠ CAUTION	Blasting of oil contaminated parts may result in contaminated surfaces, clogged abrasive, and/or malfunctioning of the equipment.
⚠ CAUTION	Valves must be opened slowly to allow seal to function correctly and to give a safe operation.
⚠ CAUTION	Never operate the PiHab™ while wearing loose hanging chains, hanging ID/Security badges or garments.
⚠ CAUTION	Never start the PiHab™ before its hoses are properly secured and safely located.
⚠ CAUTION	The re-usable PiHab™ parts should be properly maintained and stored when not in use to avoid damage to parts.
⚠ CAUTION	Always consider the workplace, access and risk factor prior to installation.
⚠ CAUTION	Always connect the hoses with safety line to fixed structure if working above 2 meters free fall.
⚠ CAUTION	Ensure proper tightness of the PiHab™ blasting enclosure upon installation. Leakages pose risk due to escape of flying grit and/or dust.

3 OPERATING INSTRUCTIONS

The following illustration shows the different parts of the PiHab™ system:

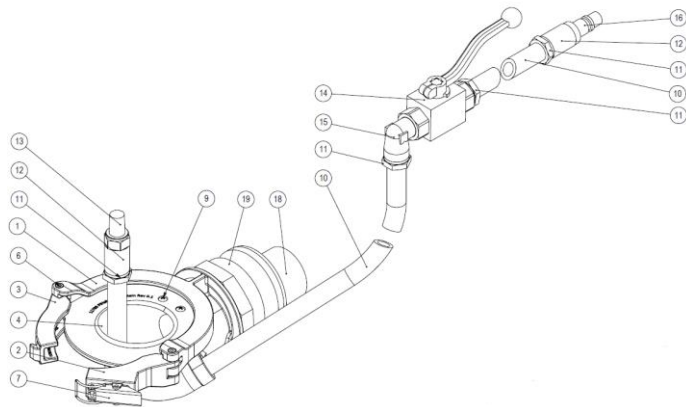

PiHab™ Funnel

- 1. Funnel main part
- 2. Funnel left part
- 3. Funnel right part
- 4. Funnel wear rubber
- 5. Locknut M5
- 6. Screw M5 x 35
- 7. Tensioner
- 8. Screw M4 x10
- 9. Screw 4.8 x 13
- 10. Antistatic air hose
- 11. Fitting
- 12. Connector
- 13. Diffusor
- 14. Air valve
- 15. 90 degree elbow
- 16. Coupling
- 17. Nut M4
- 18. Antistatic suction hose
- 19. Camlock Male 3"

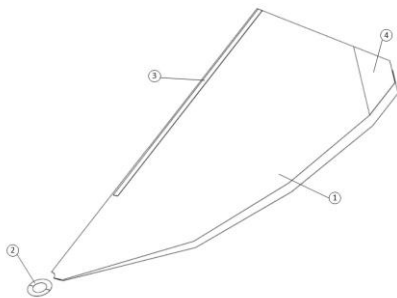

PiHab™ Bag

- 1. Plastic sheet
- 2. Mounting ring
- 3. Tape
- 4. "Sleeve"



PiHab™ Blast Nozzle

- 1. Venture Nozzle 6.4 mm
- 2. Nozzle holder
- 3. Blast hose

- The flexible, abrasive blasting enclosure PiHab™ shall only be used with a PiSys™ 100 or PiSys 1000™ closed grit blasting unit approved for PiHab-use by Pinovo.

Think over how to assembly the PiHab™ bag on the to be blast cleaned surface prior to mounting the PiHab™ bag. Once the adhesive glue is attached between two sheets of the bag, it will be difficult to remove without cutting the bag.

- If the PiHab™ Bag is to be used on a support, the slit should be cut down to the lower silver tape. This will allow for more space in order to make two openings, one for the pipe and one for the support. For large supports, the split may even be extended further down.

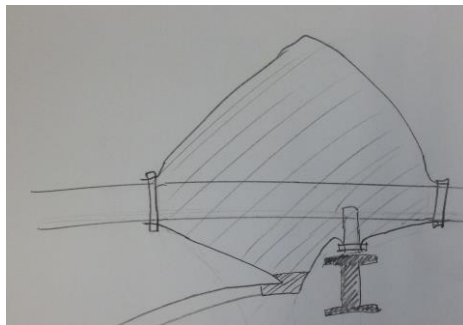

- Optional: Attach plastic sheet to the surface area where the PiHab™ shall be mounted in order to prevent contamination.

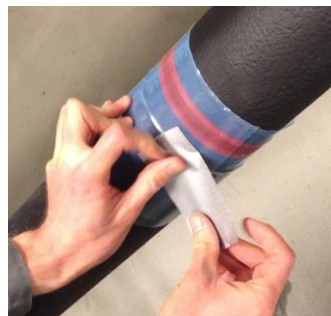

- Mount the plastic foil of the PiHab™ Bag to the surface.



- Attach bag PiHab™ Bag first around the surface. Ensure tight fit at both ends, for example by using duct tape. Make sure to get a good overlap between the two plastic sheets. Be aware not to contaminate by attaching tape directly to the surface.



- Gradually remove protective film from adhesive tape and connect the two plastic sheets of the PiHab™ Bag in order to form a complete enclosure around the to be blast cleaned surface



- Connect the PiHab™ Funnel to the PiHab™ Bag. Ensure that the funnel and hoses are not hanging only on the bag. Use a proper support. Also make sure that the funnel is placed at the lowest point, so that the used blasting media and debris can be collected easily.
- Connect all hoses from PiSys™ to PiHab™ as indicated below: Blast hose, suction hose, pressure hose from PiSys™ outlet to PiHab™ Funnel (black) and twin hose with dead man's switch (PiSwitch™ or conventional). Ensure good housekeeping of all hoses !

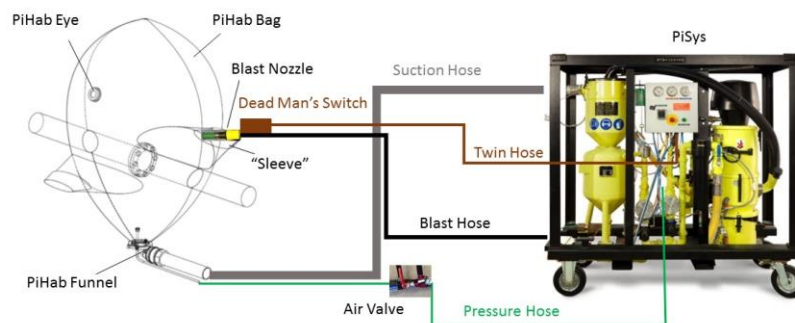

- Before using the PiHab™ system perform a visual inspection, ensuring that all parts are in place and in good condition.
- Ensure that all hoses and connections are properly fastened. Use whip-checks for blast, pressure, and suction hoses!
- Make sure that all hoses are earthed all the way from the PiSys™ unit to the blast head. Ensure earthing of the closed loop grit blasting unit PiSys™ as well.
- Inflate the PiHab™ bag by slowly opening the air valve.
- Check that all seals are tight and that there is no significant air leakage from the PiHab™ Bag
- In case leakage is observed, use for example duct tape to tighten. Excessive leakage may result in collapsing of the PiHab™ Bag and leakage of dust and/or grit during operation.
- Optional: Mount the PiHab™ Eye above the “sleeve” by pinching the plastic sheet with the spike and screwing it into the plastic sheet



- Open the “sleeve” as shown below. Insert the Blast Nozzle into the sleeve.

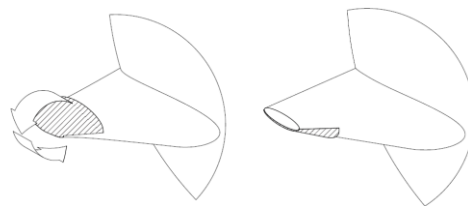

- When starting to work with the PiHab™, the Blast Nozzle **MUST** be placed against the surface that is intended for blasting. Blasting directly at the PiHab™ Bag should be avoided. If this is unavoidable, the plastic sheeting should be reinforced with fiber tape or the like.
- You must **NEVER** place your hand or fingers underneath the Blast Nozzle of the PiHab™.
- To be used with Pinovo® Blasting Grit (size F12 – F46) or similar quality blasting media.
- Recommended process parameters (PiSys™ 100):
 - Blast pressure: 4 – 5 bar
 - Suction pressure: 4 – 5 bar
 - Grit feed: 4 turns

- To start blast cleaning with the PiHab™, activate the dead man's handle. The system will automatically actuate the blasting nozzles and stop after one cycle.



- In general, the PiHab™ Funnel will balance the suction and air flow within a working range within the PiHab™ Bag. However, you may reduce the compressed air flow during blast cleaning operation by using the air valve, in case the PiHab™ Bag further inflates during operation.
- When stopping/pausing the blast operation, release the dead man's handle. Wait until the system has come to a complete stop (no grit passing through) before lifting the blast nozzle off the blast area and removing from the sleeve.
- Check the plastic sheet of the PiHab™ Bag regularly for damages. Shake the PiHab™ Bag to put grit into the PiHab™ Funnel. In case of longer exposure to blasting grit, the plastic sheet may get pinched and will not be able to provide containment.
- If you need to reposition the Blasting Nozzle, you may remove the Blasting Nozzle from the first "sleeve", close this "sleeve" again, open the second "sleeve", and insert the Blasting Nozzle. Similarly, you reposition the PiHab™ Eye by removing it from the first opening, tightening this opening with tape, and inserting it above the second "sleeve".
- In case you are not able to access all areas that need to be blast cleaned, you may cut an additional opening into the plastic sheet, where you can insert the Blasting Nozzle. You may use duct tape for tightening around the blast hose.
- Prior to re-starting the blast cleaning operation, ensure the tightness off the PiHab™ Bag.
- After blast cleaning, you may move remaining blasting media and debris manually towards the funnel in order to be recycled.

- Upon completion of the blast cleaning work, remove the Blasting Nozzle and PiHab™ Eye from the PiHab™ Bag. Remove the PiHab™ Bag from the surface, disassemble the PiHab™ Funnel from the plastic. Ensure that any remaining blasting media and debris will be contained during this operation. Dispose the used PiHab™ Bag in accordance with local waste regulations.
- Remove dust and clean the PiHab™ Funnel and Eye.
- Check the Blasting Nozzle, PiHab™ Funnel and Eye for damages and wear prior to further use.
- The PiHab™ closed loop grit blasting tool in combination with the PiSys™ blast and recycling unit, Pinovo® hoses, and Pinovo® Blasting Grit is approved for operation in potentially explosive atmospheres (ATEX zone 2) – see also chapter 5.

4 WEAR PARTS

- **Only use original replacement hoses supplied by Pinovo.** Use of wear parts not supplied by Pinovo and/or other repair methods may compromise function and operational safety.

⚠ WARNING

- Before changing wear parts, ensure that the system cannot be started, for example by either:
 - Depressurizing the system (PiSys™) or
 - Disconnecting the dead man twin hose
- Check the PiHab™ Funnel wear rubber for wear. In case the thickness is reduced to less than 2 mm, exchange the wear rubber.
- Check blast hoses and suction hoses for wear on a regular basis. In case of significant wear, the hoses need to be replaced.

⚠ WARNING

- Using worn-out hoses can cause dust and/or grit leakage and may result in damage to persons and/or the surroundings.
- Check blast nozzles for wear on a regular basis. In case of significant wear (nozzle opening > 5 mm), the nozzles need to be replaced. You may use a 5 mm hex key, bore, M5 screw or similar for testing (see below)

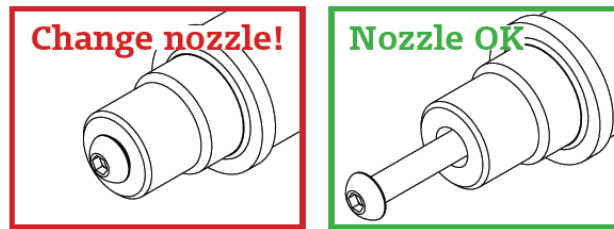

<p>PiHab™ Funnel Wear Rubber</p> <p>Replacement wear rubber for PiHab™ Funnel</p>	
<p>PiHab™ Funnel – Diffusor</p> <p>Diffusor in order to reduce exit velocity and sound emission of the compressed air stream into PiHab™ Bag</p>	
<p>PiHab™ Blast Nozzle</p> <p>6.4 mm Venturi replacement nozzle, 50 mm coarse thread</p>	

Wear parts can be ordered by contacting your local Pinovo representative.

5 ATEX

The flexible, abrasive blasting enclosure PiHab™ closed-loop grit blasting tool can be used in potentially explosive atmospheres zone 2 (subgroup IIA T4) for treatment of steel surfaces. The compliance with the requirements of the European Directive ATEX 94/9/EC is provided for use in combination with:

- an ATEX-conform PiSys™ 100 or PiSys™ 1000 closed-loop grit blasting unit – grounded according to instruction
- antistatic Pinovo suction and blast hoses
- Pinovo Blasting Grit up to size F12



Pinovo cannot affirm compliance with the requirements of the European Directive ATEX 94/9/EC, if the PiHab™ tool is used in combination with other blasting equipment, other hoses, and/or other blasting media.

6 ACCESSORIES

The following accessories are available for working with the PiHab™ tool.

<p>PiHab™ Eye</p> <p>Mobile porthole that can be attached to the PiHab™ Bag at different places in order to improve visibility.</p> <p>For more information, please, contact your local Pinovo representative.</p>	
---	---

7 TECHNICAL DATA

Size L x W x H (mm), excluding hoses	<table> <tr> <td>Bag:</td> <td>2400 x 2300 x 5</td> </tr> <tr> <td>Funnel:</td> <td>220 x 280 x 130</td> </tr> </table>	Bag:	2400 x 2300 x 5	Funnel:	220 x 280 x 130
Bag:	2400 x 2300 x 5				
Funnel:	220 x 280 x 130				
Weight (kg)	<table> <tr> <td>Bag:</td> <td>ca. 2 kg</td> </tr> <tr> <td>Funnel:</td> <td>ca. 2.5 kg</td> </tr> </table>	Bag:	ca. 2 kg	Funnel:	ca. 2.5 kg
Bag:	ca. 2 kg				
Funnel:	ca. 2.5 kg				
Nozzle Type	6.4 mm Venturi nozzle				
ATEX conformity	  II 2G IIA T4				

Main Office

Visit: Sanddalsringen 3, NO-5225 Nesttun

Postal: PO Box 154, NO-5828 Bergen

Country: Norway

Phone: +47 907 55 500

www.pinovo.com

Pinovo UK

Visit/Postal: C/O AquaTerra Group,
AquaTerra House, Toftills Ave., Midmill
Business Park, Kintore, Aberdeen, AB51 0QP

Country: Scotland

Phone: +44 07828 077543